



Low voltage AC drives

ABB general purpose drives ACS550 0.75 to 355 kW/1 to 500 hp Catalog

Selecting and ordering your drive

Build up your own ordering code using the type code key below or contact your local ABB drives sales office and let them know what you want. Use page 3 as a reference section for more information.

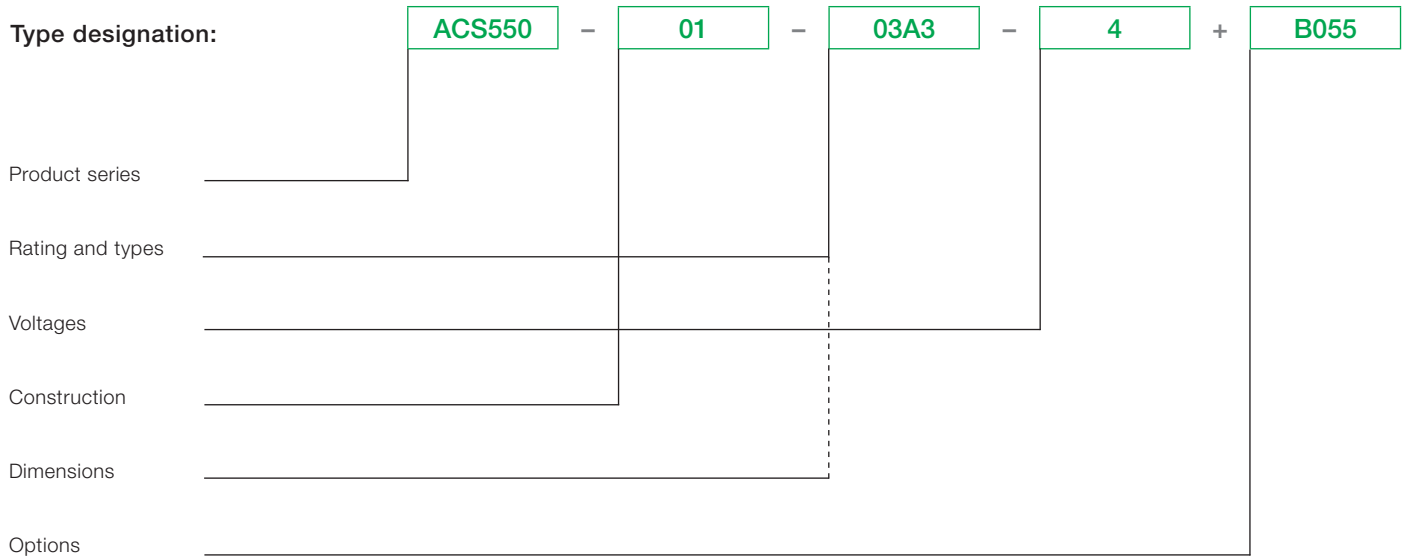

Contents

ABB general purpose drives, ACS550

Introduction to ACS550	4
Technical data	5
Ratings, types, voltages and construction	6
Dimensions	7
Electromagnetic compatibility	7
Assistant control panel	8
Options	8
Control interfaces	8
Plug-in options	9
External options	10
Cooling and fuses	12
Control connections	13
Services	14

Introduction to ACS550

ACS550 - 01 - 03A3 - 4 + B055

ABB general purpose drives

ABB general purpose drives are simple to buy, install, configure and use, saving considerable time. They are widely available through ABB channel partners. The drives have common user and process interfaces with fieldbuses, common software tools for sizing, commissioning, maintenance and common spare parts.

Applications

ABB general purpose drives can be used in a wide range of industries. Typical applications include pump, fan and constant torque use, such as conveyors. ABB general purpose drives are ideal in those situations where there is a need for simplicity to install, commission and use and where customizing or special product engineering is not required.

Highlights

- FlashDrop tool
- Intuitive use with assistant control panel
- Swinging choke for superior harmonic reduction
- Vector control
- Coated boards for harsh environments
- Built-in category C2 EMC filter (1st environment) as standard
- Flexible fieldbus system with built-in Modbus and numerous internally mountable fieldbus adapters
- UL, cUL, CE, C-Tick and GOST R approved
- RoHS compliant

Feature	Advantage	Benefit
Energy efficiency counters	Several counters to illustrate saved energy (kWh), carbon dioxide emissions (CO ₂) and cost in local currency.	Shows direct impact on energy bill and helps control operational expenditure (OPEX).
Load analyzer	Load analyzer saves process data, such as current and torque values, which can be used to analyze the process and dimensioning of the drive and motor.	Optimized dimensioning of the drive, motor and process.
FlashDrop tool	Faster and easier drive set-up and commissioning.	Patented, fast, safe and trouble-free parametrization method without electricity.
Assistant control panel	Two soft-keys, function of which changes according to the state of the panel. Built-in help function via dedicated button. Real-time clock, allows timed tracing of faults and setting of parameters to activate at various times of day. Changed parameters -menu.	Easy commissioning. Fast set-up. Easier configuration. Rapid fault diagnosis. Quick access to recent parameter changes.
Commissioning assistants	PID controller, real-time clock, serial communications assistant, drive optimizer, startup assistant.	Easy set-up of parameters.
Maintenance assistant	Monitors consumed energy (kWh), running hours or motor rotation.	Takes care of preventative maintenance of drive, the motor or run application.
Intuitive features	Noise optimization. Increases switching frequency of drive when drive temperature is reduced. Controlled cooling fan: the drive is cooled only when necessary.	Considerable motor noise reduction. Reduces inverter noise and improves energy efficiency.
Choke	Patented swinging choke - matches the right inductance to the right load, thereby suppressing and reducing harmonics.	Reduces total harmonic distortion (THD) emissions up to 25%.
Vector control	Improved motor control performance.	Enables wider range of applications.
Built-in EMC filter	Category C2 (1 st environment) and category C3 (2 nd environment) RFI filters as standard.	No need for additional external filtering.
Brake chopper	Built-in up to 11 kW.	Reduced cost.
Connectivity	Built-in Modbus using EIA-485. Simple to install: - Easy connection of cables - Easy connection to external fieldbus systems through multiple I/Os and plug-in options	Reduced cost. Reduced installation time. Secure cable connections.
Mounting template	Supplied separately with unit.	Quick and easy to mark mounting screw holes on installation surface.
RoHS compliant	ACS550 drives comply with EU Directive RoHS 2002/95/CE restricting the use of certain hazardous substances.	Environmentally friendly product.

Technical data

ACS550 - 01 - 03A3 - 4 + B055

Mains connection		Programmable control connections	
Voltage and power range	3-phase, 380 to 480 V, +10/- 15%, 0.75 to 355 kW 3-phase, 208 to 240 V, +10/- 15%, 0.75 to 75 kW Auto-identification of input line	Two analog inputs	Voltage signal 0 (2) to 10 V, $R_{in} > 312 \text{ k}\Omega$ single-ended Current signal 0 (4) to 20 mA, $R_{in} = 100 \text{ }\Omega$ single-ended Potentiometer reference value 10 V $\pm 2\%$ max. 10 mA, $R < 10 \text{ k}\Omega$
Frequency	48 to 63 Hz	Maximum delay	12 to 32 ms
Power factor	0.98	Resolution	0.1%
Motor connection		Accuracy	$\pm 1\%$
Voltage	3-phase, from 0 to U_{SUPPLY}	Two analog outputs	0 (4) to 20 mA, load $< 500 \text{ }\Omega$
Frequency	0 to 500 Hz	Accuracy	$\pm 3\%$
Continuous loading capability (constant torque at a max ambient temperature of 40 °C)	Rated output current I_{2N}	Auxiliary voltage	24 V DC $\pm 10\%$, max. 250 mA
Overload capacity (at a max. ambient temperature of 40 °C)	At normal use $1.1 \times I_{2N}$ for 1 minute every 10 minutes At heavy-duty use $1.5 \times I_{2hd}$ for 1 minute every 10 minutes Always $1.8 \times I_{2hd}$ for 2 seconds every 60 seconds	Six digital inputs	12 to 24 V DC with internal or external supply, PNP and NPN
Switching frequency	Default 4 kHz	Input impedance	2.4 k Ω
Selectable	1 kHz, 2 kHz, 4 kHz, 8 kHz, 12 kHz	Maximum delay	5 ms ± 1 ms
Acceleration time	0.1 to 1800 s	Three relay outputs	Maximum switching voltage 250 V AC/30 V DC
Deceleration time	0.1 to 1800 s	Maximum switching current	6 A/30 V DC; 1500 V A/230 V AC
Speed control		Maximum continuous current	2 A rms
Open loop	20% of motor nominal slip	Serial communication	EIA-485 Modbus protocol
Closed loop	0.1% of motor nominal speed	Product compliance	
Open loop	$< 1\%$ s with 100% torque step	Low Voltage Directive 2006/95/EC	
Closed loop	0.5% s with 100% torque step	EMC Directive 2004/108/EC	
Torque control		Quality assurance system ISO 9001	
Open loop	< 10 ms with nominal torque	Environmental system ISO 14001	
Closed loop	< 10 ms with nominal torque	UL, cUL, CE, C-Tick and GOST R approvals	
Open loop	$\pm 5\%$ with nominal torque	RoHS compliant	
Closed loop	$\pm 2\%$ with nominal torque		
Environmental limits			
Ambient temperature	-15 to 50 °C	No frost allowed. From 40 to 50 °C with derating.	
Altitude	Output current	Rated current available at 0 to 1000 m. In altitudes from 1000 to 4000 m (3300 to 13,200 ft) above sea level, the derating is 1% for every 100 m (330 ft). If the installation site is higher than 2000 m (6600 ft) above sea level, please contact your local ABB distributor or office for further information.	
Relative humidity	5 to 95%, no condensation allowed		
Degree of protection	IP21 or IP54 ($\leq 160 \text{ kW}$)		
Enclosure colour	NCS 1502-Y, RAL 9002, PMS 420 C		
Contamination levels	IEC 721-3-3		
Transportation	No conductive dust allowed		
Storage	Class 1C2 (chemical gases), Class 1S2 (solid particles)		
Operation	Class 2C2 (chemical gases), Class 2S2 (solid particles)		
	Class 3C2 (chemical gases), Class 3S2 (solid particles)		

Ratings, types, voltages and construction

ACS550 - 01 - 03A3 - 4 + B055

Type designation

Drive's type designation (shown above and in column 7 of the tables on the right side) identifies your drive by construction, current rating and voltage range. Once you have selected the type designation, the frame size (column 8) can be used to determine the drives dimensions, shown on the next page.

Construction

"01" within the type designation (shown above) varies depending on the drive mounting arrangement, and power rating.

01 = wall-mounted

02 = free-standing

Voltages

The ACS550 is available in two voltage ranges:

4 = 380 to 480 V

2 = 208 to 240 V

Insert either "4" or "2", depending on your chosen voltage, into the type designation shown above.

3-phase supply voltage 380 to 480 V

Wall-mounted units

Ratings						Type designation	Frame size
Normal use			Heavy-duty use				
P_N kW	P_N hp	I_{2N} A	P_{hd} kW	P_{hd} hp	I_{2hd} A		
1.1	1.5	3.3	0.75	1	2.4	ACS550-01-03A3-4	R1
1.5	2	4.1	1.1	1.5	3.3	ACS550-01-04A1-4	R1
2.2	3	5.4	1.5	2	4.1	ACS550-01-05A4-4	R1
3	4	6.9	2.2	3	5.4	ACS550-01-06A9-4	R1
4	5.4	8.8	3	4	6.9	ACS550-01-08A8-4	R1
5.5	7.5	11.9	4	5.4	8.8	ACS550-01-012A-4	R1
7.5	10	15.4	5.5	7.5	11.9	ACS550-01-015A-4	R2
11	15	23	7.5	10	15.4	ACS550-01-023A-4	R2
15	20	31	11	15	23	ACS550-01-031A-4	R3
18.5	25	38	15	20	31	ACS550-01-038A-4	R3
22	30	45	18.5	25	38	ACS550-01-045A-4	R3
30	40	59	22	30	45	ACS550-01-059A-4	R4
37	50	72	30	40	59	ACS550-01-072A-4	R4
45	60	87	37	60	72	ACS550-01-087A-4	R4
55	100	125	45	75	96	ACS550-01-125A-4	R5
75	125	157	55	100	125	ACS550-01-157A-4	R6
90	150	180	75	125	156	ACS550-01-180A-4	R6
110	150	205	90	125	162	ACS550-01-195A-4	R6
132	200	246	110	150	192	ACS550-01-246A-4	R6
160	200	290	132	200	246	ACS550-01-290A-4	R6

Free-standing units

200	300	368	160	250	302	ACS550-02-368A-4	R8
250	400	486	200	350	414	ACS550-02-486A-4	R8
280	450	526	250	400	477	ACS550-02-526A-4	R8
315	500	602	280	450	515	ACS550-02-602A-4	R8
355	500	645	315	500	590	ACS550-02-645A-4	R8

3-phase supply voltage 208 to 240 V

Wall-mounted units

Ratings						Type designation	Frame size
Normal use			Heavy-duty use				
P_N kW	P_N hp	I_{2N} A	P_{hd} kW	P_{hd} hp	I_{2hd} A		
0.75	1.0	4.6	0.75	0.8	3.5	ACS550-01-04A6-2	R1
1.1	1.5	6.6	0.75	1.0	4.6	ACS550-01-06A6-2	R1
1.5	2.0	7.5	1.1	1.5	6.6	ACS550-01-07A5-2	R1
2.2	3.0	11.8	1.5	2.0	7.5	ACS550-01-012A-2	R1
4.0	5.0	16.7	3.0	3.0	11.8	ACS550-01-017A-2	R1
5.5	7.5	24.2	4.0	5.0	16.7	ACS550-01-024A-2	R2
7.5	10.0	30.8	5.5	7.5	24.2	ACS550-01-031A-2	R2
11.0	15.0	46.2	7.5	10.0	30.8	ACS550-01-046A-2	R3
15.0	20.0	59.4	11.0	15.0	46.2	ACS550-01-059A-2	R3
18.5	25.0	74.8	15.0	20.0	59.4	ACS550-01-075A-2	R4
22.0	30.0	88.0	18.5	25.0	74.8	ACS550-01-088A-2	R4
30.0	40.0	114	22.0	30.0	88.0	ACS550-01-114A-2	R4
37.0	50.0	143	30.0	40	114	ACS550-01-143A-2	R6
45.0	60.0	178	37.0	50	150	ACS550-01-178A-2	R6
55.0	75.0	221	45.0	60	178	ACS550-01-221A-2	R6
75.0	100	248	55.0	75	192	ACS550-01-248A-2	R6

Normal use vs heavy-duty use. For the majority of pump, fan and conveyor applications, select "Normal use" figures. For high overload requirements, select "Heavy-duty use" figures. If in doubt contact your local ABB sales office or your drives distributor.

P_N for kW = Typical motor power in 400 V at normal use

P_N for hp = Typical motor power in 460 V at normal use

P_{hd} for kW = Typical motor power in 400 V at heavy-duty use

P_{hd} for hp = Typical motor power in 460 V at heavy-duty use

I_{2N} for A = Continuous rms current. 10% overload is allowed for one minute in ten minutes.

I_{2hd} for A = Continuous rms current. 50% overload is allowed for one minute in ten minutes.

Dimensions

ACS550 - 01 - 03A3 - 4 + B055

Wall-mounted drives



H1 = Height with cable connection box
 H2 = Height without cable connection box
 W = Width
 D = Depth

Free-standing drives

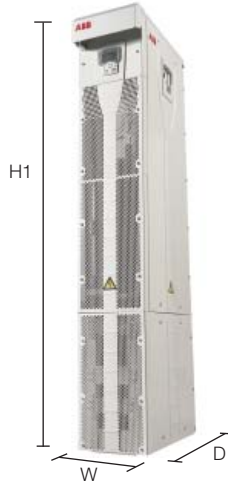

Wall-mounted units

Frame size	Dimensions and weights								
	IP21 / UL type 1					IP54 / UL type 12 ²⁾			
	H1	H2	W	D	Weight	H	W	D	Weight
	mm	mm	mm	mm	kg	mm	mm	mm	kg
R1	369	330	125	212	6.5	461	213	234	8
R2	469	430	125	222	9	561	213	245	11
R3	583	490	203	231	16	629	257	254	17
R4	689	596	203	262	24	760	257	284	26
R5	736	602	265	286	34	775	369	309	42
R6	888 ¹⁾	700	302	400	69	924 ³⁾	410	423	86

¹⁾ ACS550-01-246A-4 and ACS550-01-290A-4: 979 mm

²⁾ UL Type 12 not available for ACS550-01-290A-4

³⁾ ACS550-01-290A-4: 1119 mm

Free-standing units

R8	2024	n/a	347 ¹⁾	617 ¹⁾	230
----	------	-----	-------------------	-------------------	-----

¹⁾ The dimensions apply to bookshelf mounting. In flat type mounting the width and depth change places.
 n/a = not applicable

Electromagnetic compatibility

The EMC product standard (EN 61800-3 + Amendment A11[2000]) covers the specific EMC requirements stated for drives (tested with motor and cable) within the EU. The new revision of 61800-3 (2004) product standard can be applied from now on, but latest from 1st October 2007. EMC standards such as EN 55011, or EN 61000-6-3/4, apply to industrial and household equipment and systems including drive component inside. Drive units complying

with requirements of EN 61800-3 are always compliant with comparable categories in EN 55011 and EN 61000-6-3/4, but not necessarily vice versa. EN 55011 and EN 61000-6-3/4 do not specify cable length nor require a motor to be connected as a load. The emission limits are comparable according to the following table, EMC standards.

EMC according to EN61800-3

1st environment restricted distribution for frame sizes R3, R4 with 75 m motor cables and for frame sizes R1, R2, R5, R6 with 100 m motor cables as standard.

2nd environment unrestricted distribution for frame sizes R1 to R4 with 300 m motor cables and for frame sizes R5 to R8 with 100 m motor cables as standard.

These cable lengths are for EMC purposes only. Operational cable lengths are available in the output choke selection table on page 11. For longer motor cable lengths, external EMC filters are available on request.

EMC standards in general

EN 61800-3/A11 (2000), product standard	EN 61800-3 (2004), product standard	EN 55011, product family standard for industrial, scientific and medical (ISM) equipment
1 st environment, unrestricted distribution	Category C1	Group 1 Class B
1 st environment, restricted distribution	Category C2	Group 1 Class A
2 nd environment, unrestricted distribution	Category C3	Group 2 Class A
2 nd environment, restricted distribution	Category C4	Not applicable

Assistant control panel

ACS550 - 01 - 03A3 - 4 + B055

The assistant control panel, which is delivered as standard, features a multilingual alphanumeric display for easy drive programming. The control panel has various assistants and a built-in help function to guide the user. It includes a real time clock, which can be used during fault logging and in controlling the drive, such as start/stop. The control panel can be used for copying parameters for back up or for downloading them to another drive. A large graphical display and soft keys make it extremely easy to navigate.



Options Control interfaces

ACS550 - 01 - 03A3 - 4 + B055

Panel mounting kits

To attach the control panel to the outside of a larger enclosure, two panel mounting kits are available. A simple and cost-efficient installation is possible with the ACS/H-CP-EXT kit, while the OPMP-01 kit provides a more user-friendly solution, including a panel platform that enables the panel to be removed in the same way as a drive-mounted panel. The panel mounting kits include all hardware required, including 3 m extension cables and installation instructions.



How to select options

The options shown in the table are available within the ACS550 range. Most of them have an associated 4-figure option code, which is shown in the table. It is this code that replaces B055 in the type code above. External options require a separate order line and material or type code number.

Basic control panel

The basic control panel features a single line numeric display. The panel can be used to control the drive, set the parameter values or copy them from one drive to another.



Available options

Protection class		
B055	IP54	
Control panel		
0J400	If no control panel is required	
J404	Basic control panel	ACS-CP-C
- 1)	Panel mounting kit	ACS/H-CP-EXT
- 1)	Panel holder mounting kit	OPMP-01
- 1)	Panel mounting kit IP66	ACS/H-CP-EXT-IP66
I/O options ²⁾		
L511	Relay output extension	OREL-01
Control option ²⁾		
- 1)	Encoder	OTAC-01
Fieldbus ³⁾		
K451	DeviceNet™	RDNA-01
K452	LonWorks®	RLON-01
K454	PROFIBUS DP	RPBA-01
K457	CANopen®	RCAN-01
K462	ControlNet	RCNA-01
K466	Modbus TCP	RETA-01
K466	EtherNet/IP™	RETA-01
K467	Modbus TCP	RETA-02
K467	PROFINET IO	RETA-02
- 1)	PowerLink	REPL-02
- 1)	EtherCAT®	RECA-01
Tools		
- 1)	FlashDrop	MFDT-01
- 1)	DriveWindow Light and USB serial adapters	DriveWindow Light
Remote monitoring		
- 1)	Ethernet adapter	SREA-01

¹⁾ Ordering with a separate material code number.

²⁾ One slot available for relay or encoder.

³⁾ One slot available for fieldbus adapter. Modbus built-in as standard.

Options

Plug-in options

ACS550 - 01 - 03A3 - 4 + B055

FlashDrop tool

ACS550 drives have an interface for a FlashDrop tool. FlashDrop is a powerful palm sized tool for fast and easy parameter selection and setting of an unpowered drive. The user can hide each parameter/group from the drive's display, which protects the drive and connected machinery. For more information on the FlashDrop tool, please see page 10.

Relay output extension option module

This plug-in option offers three additional relay outputs. They can be used, for example, in pump and fan control or many supervisory functions. All the relays can be programmed to on/off by using the assistant control panel's clock. Alternatively, fieldbus can be used to control any external components in the system.

Encoder feedback option module

The general purpose drives can accommodate an encoder module. Using an encoder for speed feedback is a straight forward way to increase motor control in many applications.

Plug-in fieldbus module

The plug-in fieldbus options bring connectivity to major automation systems. A single twisted pair avoids large amounts of conventional cabling, thereby reducing cost and increasing system reliability.

ACS550 supports the following fieldbus options:

- DeviceNet™
- LonWorks®
- PROFIBUS DP
- CANopen®
- ControlNet
- Modbus TCP
- EtherNet/IP™
- PROFINET IO
- PowerLink
- EtherCAT®

For type codes see page 8

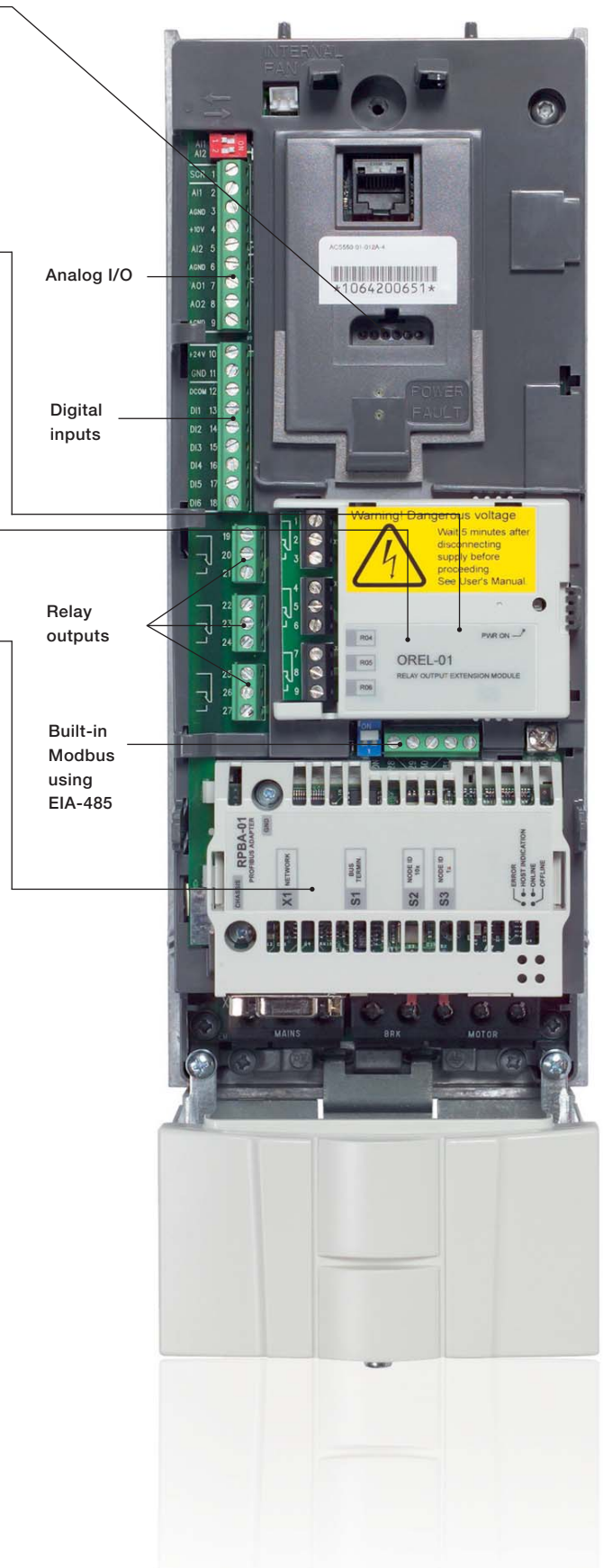

Options

External options

FlashDrop tool

FlashDrop is a powerful palm sized tool for fast and easy parameter selecting and setting. It gives the possibility to hide selected parameters to protect the machine. Only the parameters needed in the application are shown. The tool can copy parameters between two drives or between a PC and a drive. All the above can be done without a power connection to the drive. The interface for FlashDrop is available in all wall-mounted units.

DrivePM

DrivePM (drive parameter manager) is a tool to create, edit and copy parameter sets for the FlashDrop tool. For each parameter/group the user has a possibility to hide it, which means that the drive user does not see the parameter/group at all.

DrivePM requirements

- Supported operating systems: Windows NT/2000/XP/Vista

FlashDrop package includes

- FlashDrop tool
- DrivePM software (CD-rom)
- User's manual (hardcopy and PDF)
- RS232 cable for connection between PC and the FlashDrop tool
- Battery charger



SREA-01 Ethernet adapter

SREA-01 Ethernet adapter with remote monitoring access can send process data, data logs and event messages independently, without a PLC or a dedicated on-site computer. It has an internal web server for configuration and drive access.



DriveWindow Light

DriveWindow Light is an easy-to-use startup and maintenance tool for ACS550 drives. It can be used in an offline mode, which enables parameter setting at the office even before going to the actual site. The parameter browser enables viewing, editing and saving of parameters. The parameter comparison feature makes it possible to compare parameter values between the drive and the file. With the parameter subset you can create your own parameter sets. Controlling of the drive is naturally one of the features in DriveWindow Light. With this software tool, you can monitor up to four signals simultaneously. This can be done in both graphical and numerical format. Any signal can be set to stop the monitoring from a predefined level.

Startup wizards

Startup wizards make the setting of parameters easy. Simply launch the wizard, select an appropriate assistant eg, for setting analog outputs, and all parameters related to this function are shown together with help pictures.

Highlights

- Editing, saving and downloading parameters
- Graphical and numerical signal monitoring
- Drive control
- Startup wizards

DriveWindow Light requirements

- Supported operating systems: Windows NT/2000/XP/Vista

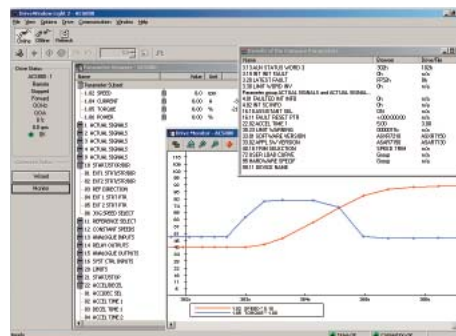

Options

External options

Brake units and choppers

Frame sizes R1 to R2 are delivered with integrated brake choppers as standard. Other units can use the compact-sized brake units which include brake chopper and resistor. For more information please refer to the ACS-BRK brake units installation and startup guide.

Brake units technical data

Frequency converter input voltage	Resistor ohm	Continuous output W	Max. output 20 s W	Brake unit type code
200 to 240 V AC	32	2000	4500	ACS-BRK-C
380 to 480 V AC			12000	
200 to 240 V AC	10.5	7000	14000	ACS-BRK-D
380 to 480 V AC			42000	

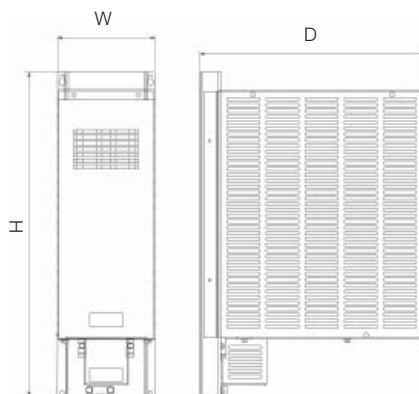

Dimensions

Width (W) mm	Height (H) mm	Depth (D) mm	Weight kg	Brake unit type code
150	500	347	7.5	ACS-BRK-C
270	600	450	20.5	ACS-BRK-D

Output chokes

Output chokes are used when motor cables above normal length are required.

Cable can be roughly 1.5 times standard cable length, see below.

Type designation	Frame size	Nominal current I_{2N} A	Output choke type code ¹⁾	Choke thermal current I A	Max. cable length without choke ²⁾ m	Max. cable length with choke ³⁾ m
$U_N = 380$ to 480 V (380, 400, 415, 440, 460, 480 V)						
ACS550-01-03A3-4	R1	3.3	NOCH-0016-6X	19	100	150
ACS550-01-04A1-4	R1	4.1	NOCH-0016-6X	19	100	150
ACS550-01-05A4-4	R1	5.4	NOCH-0016-6X	19	100	150
ACS550-01-06A9-4	R1	6.9	NOCH-0016-6X	19	100	150
ACS550-01-08A8-4	R1	8.8	NOCH-0016-6X	19	100	150
ACS550-01-012A-4	R1	11.9	NOCH-0016-6X	19	100	150
ACS550-01-015A-4	R2	15.4	NOCH-0016-6X	19	200	250
ACS550-01-023A-4	R2	23	NOCH-0030-6X	41	200	250
ACS550-01-031A-4	R3	31	NOCH-0030-6X	41	200	250
ACS550-01-038A-4	R3	38	NOCH-0030-6X	41	200	250
ACS550-01-045A-4	R3	45	NOCH-0070-6X	112	200	300
ACS550-01-059A-4	R4	59	NOCH-0070-6X	112	200	300
ACS550-01-072A-4	R4	72	NOCH-0070-6X	112	200	300
ACS550-01-087A-4	R4	87	NOCH-0070-6X	112	300	300
ACS550-01-125A-4	R5	125	NOCH-0120-6X	157	300	300
ACS550-01-157A-4	R6	157	FOCH-0260-70	289	300	300
ACS550-01-180A-4	R6	180	FOCH-0260-70	289	300	300
ACS550-01-195A-4	R6	205	FOCH-0260-70	289	300	300
ACS550-01-246A-4	R6	246	FOCH-0260-70	289	300	300
ACS550-01-290A-4	R6	290	FOCH-0320-50	445	300	300
ACS550-02-368A-4	R8	368	FOCH-0320-50	445	300	300
ACS550-02-486A-4	R8	486	FOCH-0610-70	720	300	300
ACS550-02-526A-4	R8	526	FOCH-0610-70	720	300	300
ACS550-02-602A-4	R8	602	FOCH-0610-70	720	300	300
ACS550-02-645A-4	R8	645	FOCH-0610-70	720	300	300

¹⁾ The last digit of the output choke type defines the degree of protection; X stands for 2 = IP22 or 5 = IP54, 0 = IP00

²⁾ Cable lengths according to 4 kHz switching frequency

³⁾ Maximum switching frequency to be used with du/dt filter is 4 kHz

Note:

An output choke does not improve the EMC performance of the drive.

To fulfil local EMC requirements use sufficient RFI filtering.

For more information refer to the ACS550 User's manual / Technical reference.

Cooling and fuses

Cooling

ACS550 is fitted with cooling air fans. The cooling air must be free from corrosive materials and not above the maximum ambient temperature of 40 °C (50 °C with derating). For more specific environmental limits see page 5.

Cooling air flow 380 to 480 V units

Type designation	Frame size	Heat dissipation		Air flow	
		W	BTU/Hr	m³/h	ft³/min
ACS550-01-03A3-4	R1	40	137	44	26
ACS550-01-04A1-4	R1	52	178	44	26
ACS550-01-05A4-4	R1	73	249	44	26
ACS550-01-06A9-4	R1	97	331	44	26
ACS550-01-08A8-4	R1	127	434	44	26
ACS550-01-012A-4	R1	172	587	44	26
ACS550-01-015A-4	R2	232	792	88	52
ACS550-01-023A-4	R2	337	1151	88	52
ACS550-01-031A-4	R3	457	1561	134	79
ACS550-01-038A-4	R3	562	1919	134	79
ACS550-01-045A-4	R3	667	2278	134	79
ACS550-01-059A-4	R4	907	3098	280	165
ACS550-01-072A-4	R4	1120	3825	280	165
ACS550-01-087A-4	R4	1440	4918	280	165
ACS550-01-125A-4	R5	1940	6625	350	205
ACS550-01-157A-4	R6	2310	7889	405	238
ACS550-01-180A-4	R6	2810	9597	405	238
ACS550-01-195A-4	R6	3050	10416	405	238
ACS550-01-246A-4	R6	3260	11134	405	238
ACS550-01-290A-4	R6	3850	13125	405	238
ACS550-02-368A-4	R8	6850	23394	1220	718
ACS550-02-486A-4	R8	7850	26809	1220	718
ACS550-02-526A-4	R8	7600	25955	1220	718
ACS550-02-602A-4	R8	8100	27663	1220	718
ACS550-02-645A-4	R8	9100	31078	1220	718

Cooling air flow 208 to 240 V units

Type designation	Frame size	Heat dissipation		Air flow	
		W	BTU/Hr	m³/h	ft³/min
ACS550-01-04A6-2	R1	55	189	44	26
ACS550-01-06A6-2	R1	73	249	44	26
ACS550-01-07A5-2	R1	81	276	44	26
ACS550-01-012A-2	R1	118	404	44	26
ACS550-01-017A-2	R1	161	551	44	26
ACS550-01-024A-2	R2	227	776	88	52
ACS550-01-031A-2	R2	285	973	88	52
ACS550-01-046A-2	R3	420	1434	134	79
ACS550-01-059A-2	R3	536	1829	134	79
ACS550-01-075A-2	R4	671	2290	280	165
ACS550-01-088A-2	R4	786	2685	280	165
ACS550-01-114A-2	R4	1014	3463	280	165
ACS550-01-143A-2	R6	1268	4331	405	238
ACS550-01-178A-2	R6	1575	5379	405	238
ACS550-01-221A-2	R6	1952	6666	405	238
ACS550-01-248A-2	R6	2189	7474	405	238

Free space requirements

Enclosure type	Space above mm	Space below mm	Space on left/right mm
Wall mounted	200	200	0
Free standing	200	0	0

Fuse connections

Standard fuses can be used with ABB general purpose drives. For input fuse connections see tables below.

Recommended input protection fuses for 380 to 480 V units

Type designation	Frame size	IEC fuses		UL fuses	
		A	Fuse type ¹⁾	A	Fuse type
ACS550-01-03A3-4	R1	10	gG	10	UL Class T
ACS550-01-04A1-4	R1	10	gG	10	UL Class T
ACS550-01-05A4-4	R1	10	gG	10	UL Class T
ACS550-01-06A9-4	R1	10	gG	10	UL Class T
ACS550-01-08A8-4	R1	10	gG	15	UL Class T
ACS550-01-012A-4	R1	16	gG	15	UL Class T
ACS550-01-015A-4	R2	16	gG	20	UL Class T
ACS550-01-023A-4	R2	25	gG	30	UL Class T
ACS550-01-031A-4	R3	35	gG	40	UL Class T
ACS550-01-038A-4	R3	50	gG	50	UL Class T
ACS550-01-045A-4	R3	50	gG	60	UL Class T
ACS550-01-059A-4	R4	63	gG	80	UL Class T
ACS550-01-072A-4	R4	80	gG	90	UL Class T
ACS550-01-087A-4	R4	125	gG	125	UL Class T
ACS550-01-125A-4	R5	160	gG	175	UL Class T
ACS550-01-157A-4	R6	200	gG	200	UL Class T
ACS550-01-180A-4	R6	250	gG	250	UL Class T
ACS550-01-195A-4	R6	250	gG	250	UL Class T
ACS550-01-246A-4	R6	250	gG	250	UL Class T
ACS550-01-290A-4	R6	315	gG	315	UL Class T
ACS550-02-368A-4	R8	400	gG	400	UL Class T
ACS550-02-486A-4	R8	500	gG	500	UL Class T
ACS550-02-526A-4	R8	630	gG	630	UL Class T
ACS550-02-602A-4	R8	630	gG	630	UL Class T
ACS550-02-645A-4	R8	800	gG	800	UL Class T

Recommended input protection fuses for 208 to 240 V units

Type designation	Frame size	IEC fuses		UL fuses	
		A	Fuse type ¹⁾	A	Fuse type
ACS550-01-04A6-2	R1	10	gG	10	UL Class T
ACS550-01-06A6-2	R1	10	gG	10	UL Class T
ACS550-01-07A5-2	R1	10	gG	10	UL Class T
ACS550-01-012A-2	R1	16	gG	15	UL Class T
ACS550-01-017A-2	R1	25	gG	25	UL Class T
ACS550-01-024A-2	R2	25	gG	30	UL Class T
ACS550-01-031A-2	R2	40	gG	40	UL Class T
ACS550-01-046A-2	R3	63	gG	60	UL Class T
ACS550-01-059A-2	R3	63	gG	80	UL Class T
ACS550-01-075A-2	R4	80	gG	100	UL Class T
ACS550-01-088A-2	R4	100	gG	110	UL Class T
ACS550-01-114A-2	R4	125	gG	150	UL Class T
ACS550-01-143A-2	R6	200	gG	200	UL Class T
ACS550-01-178A-2	R6	250	gG	250	UL Class T
ACS550-01-221A-2	R6	315	gG	300	UL Class T
ACS550-01-248A-2	R6	315	gG	350	UL Class T

¹⁾ According to IEC-60269 standard

Control connections

These connections are shown as examples only. Please refer to the ACS550 User's manual, chapter Installations, for more detailed information.

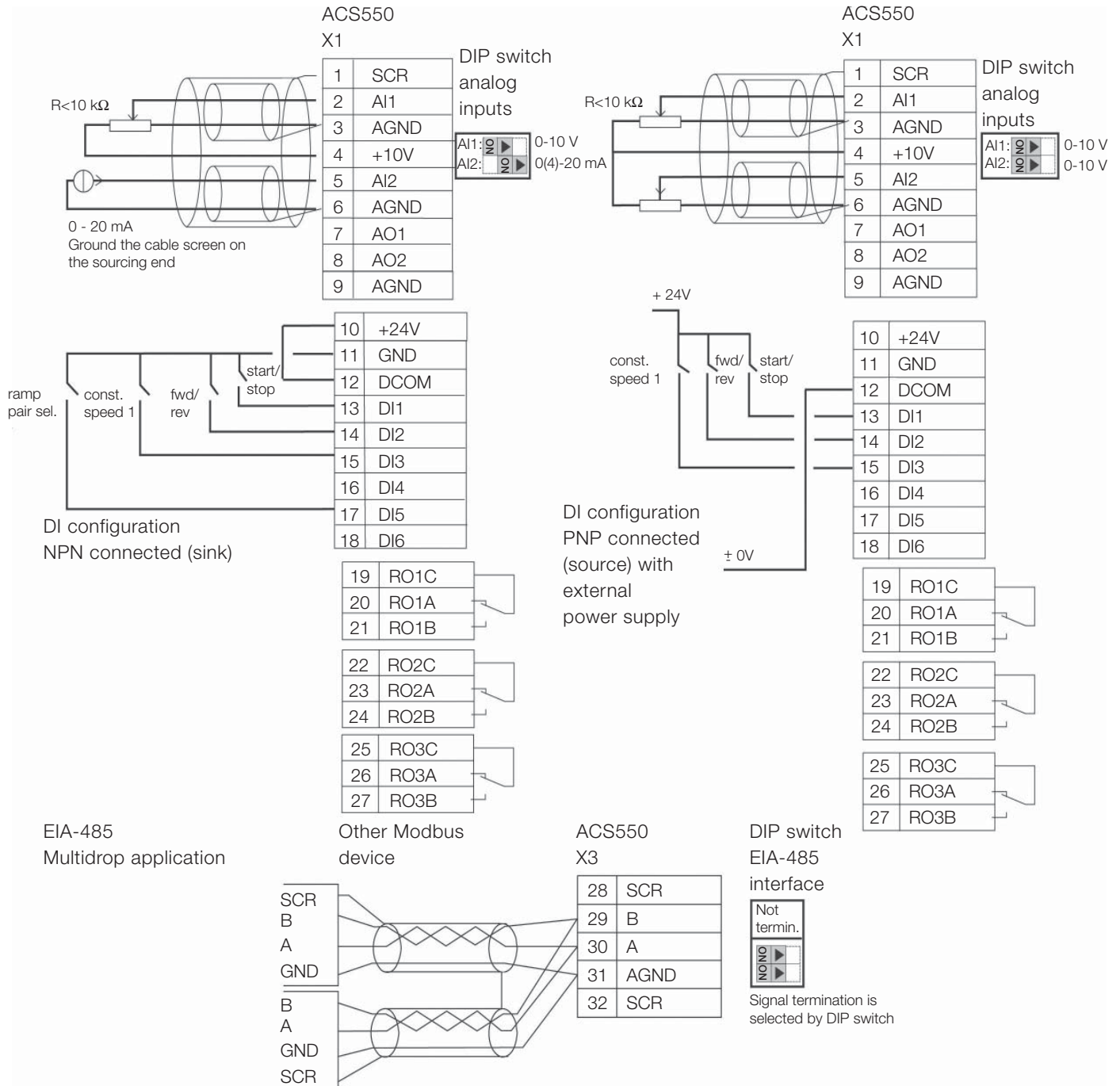

Expertise at every stage of the value chain

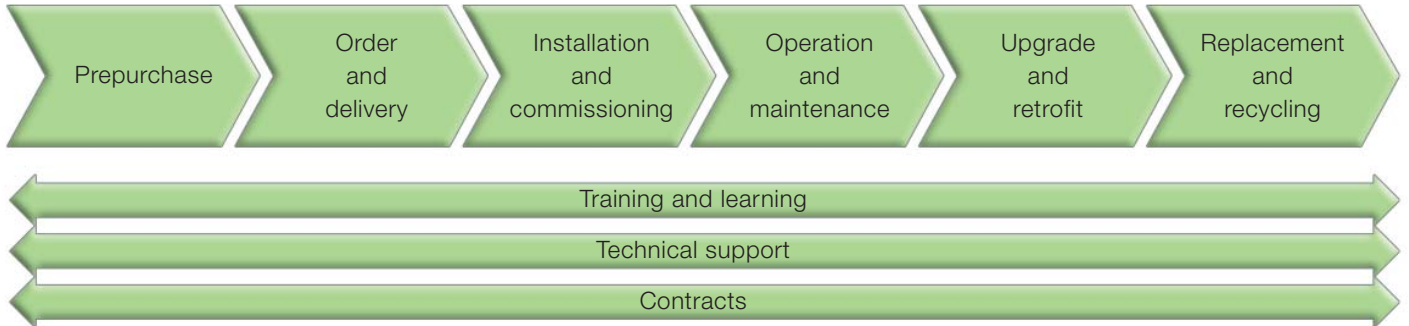

Whether you operate in industry, commerce or a utility your aims remain the same: to keep your motor-driven applications running consistently and efficiently. The life cycle services for ABB drives can help you achieve these aims by maximizing the uptime of your process while ensuring the optimum lifetime of ABB drives in a predictable, safe and low-cost manner.

The life cycle services for ABB drives span the entire value chain, from the moment you make the first enquiry about a drive through to its disposal and recycling. Throughout the value chain, ABB provides training and learning, technical support and contracts. All of this is supported by one of the most extensive global drive sales and service networks.

Secure uptime throughout the drive life cycle

ABB follows a four-phase model for the life cycle management of its drives. The life cycle phases are active, classic, limited and obsolete. Within each phase, every drive series has a defined set of services.

The four-phase drive life cycle management model provides you with a transparent method for managing your investment in drives. In each phase, you clearly see what life cycle services are available, and more importantly, what services are not available. Decisions on upgrading, retrofitting or replacing drives can be made with confidence.

ABB drive life cycle management model

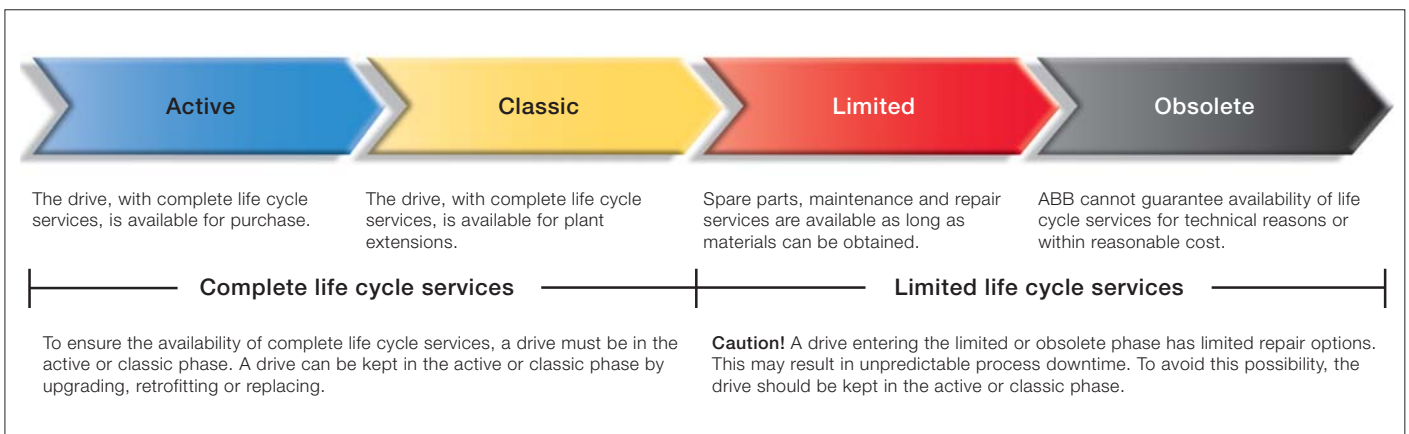

Notes

Contact us

For more information please contact your local ABB representative or visit:

www.abb.com/drives

www.abb.com/drivespartners

© Copyright 2014 ABB. All rights reserved.
Specifications subject to change without notice.

3AFE64792857 REV P EN 26.3.2014 #17067